

SIDE VIEW

100mm x 40mm X 5MM GAUGE BACKING PLATE
WELDED TO TOP REAR OF KERB INSERT

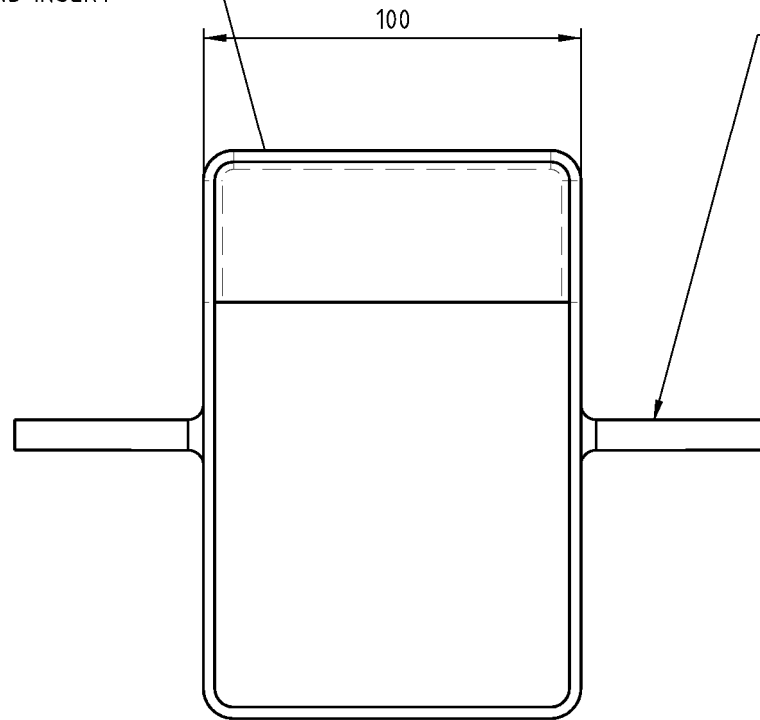

FRONT VIEW

50mm LONG x 8mm ϕ RETAINING PINS
WELDED CENTRALLY



ISOMETRIC VIEW

NOTES:

1. The Kerb Insert shall be cut from 150mm x 100mm x 5mm gauge Steel Rectangular Hollow Section with Galvanised Finish.
2. Units with 50mm Retaining Pins attached are used in the construction of new kerb. Where installation is in an existing kerb, the Retaining Pins are not required and should be omitted.
3. Existing kerbs must be precisely sawcut allowing for a snug installation of the Kerb Insert. In addition, a high strength outdoor adhesive should be used to bond the Kerb Insert to the existing concrete kerb.
4. The maximum allowable stormwater outlet pipe size is limited to 90mm.

5. Gap Filler should be applied between the rear square opening and the PVC Stormwater Pipe entering the Kerb Insert.

SCALE 1:2 @ A3 SHEET SIZE



THE CORPORATION OF THE CITY OF MARION

**GALVANISED STEEL KERB INSERT FOR DOMESTIC STREET STORMWATER OUTLET
150mm BARRIER KERB WITH 40mm LAY BACK**

Drawn : A.M.D

Date : 10 SEPTEMBER 2012

Approved :

Last Revised : 10 SEPTEMBER 2012

Ref. No. : SD-24